

Waterproof High Density

Data

Materials and finish

Shell: Steel, dimples on plug

Insulator: PBT thermoplastic, 30% glass filled,
UL94V-0 rated

Watertight frame: PBT GF, UL 94V-0, black color

O-Ring: Silicone

Epoxy sealant: Epoxy

Contact material: Copper alloy

Electrical characteristics

Contact current rating: 3.0 A

Contact resistance: 10 mΩ max.

Dielectric withstanding voltage: 1000 V AC (for 1 minute)

Insulation resistance: 5000 MΩ min.

Temperature rating: -25°C ~ +85°C

Degree of protection: IP67 according to IEC60529



High Density 90°





High Density Straight

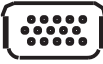
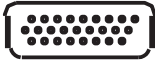

High Density Solder

Contact Variants

SHELL SIZE	HOUSING PIN	HOUSING TYPE
9	15	
15	26	
25	44	
37	62	

Standard Shell Assembly

MALE SHELL *Note: This male shell is used for all the male connectors*

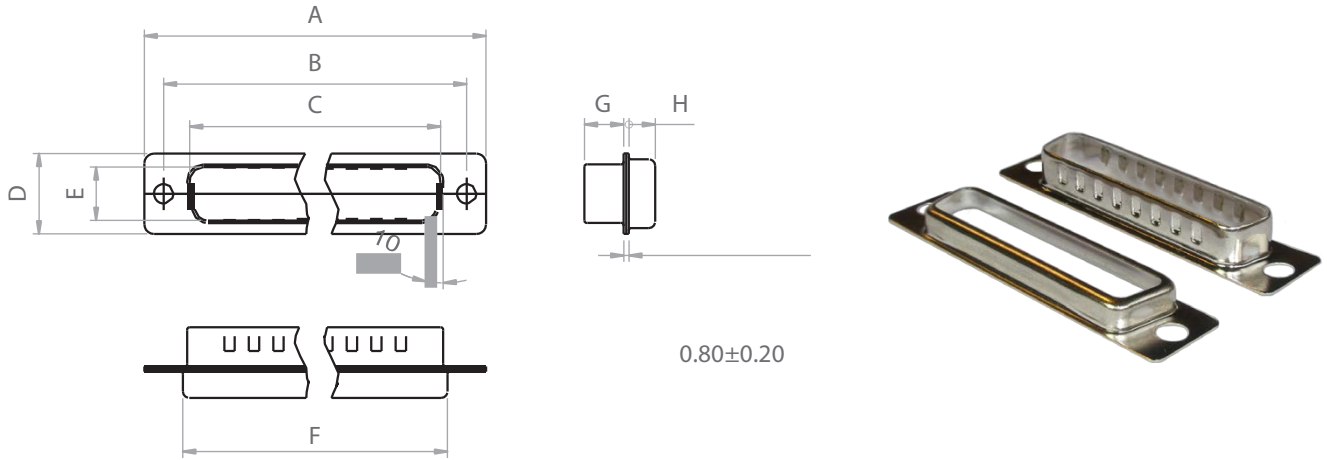

SHELL SIZE	A±0.20mm	B±0.15mm	C±0.20mm	D±0.20mm	E±0.20mm	F±0.20mm	G±0.20mm	H±0.15mm
9	30.8	25	16.9	12.5	8.3	19.25	6.1	4.1
15	39.2	33.3	25.25	12.5	8.3	27.7	6.1	4.1
25	53.05	47.05	38.95	12.5	8.3	41.2	6.1	4.1
37	69.4	63.5	55.4	12.5	8.3	57.5	6.1	4.1
50	67	61	52.8	15.3	11.15	55	6.1	4.1

FEMALE SHELL *Note: This female shell is used for all the female connectors*

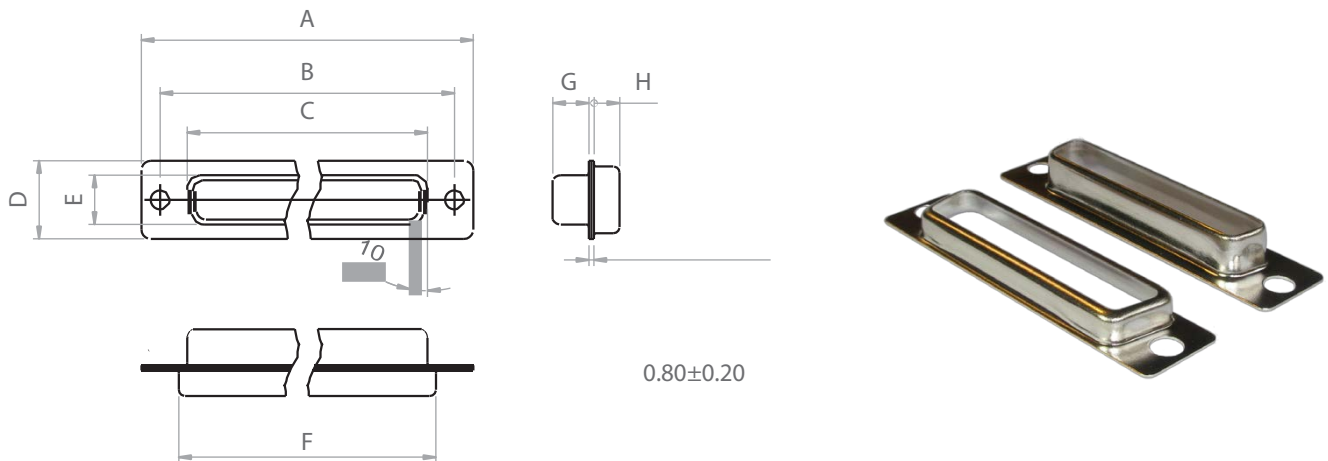

SHELL SIZE	A±0.20mm	B±0.15mm	C±0.20mm	D±0.20mm	E±0.20mm	F±0.20mm	G±0.20mm	H±0.15mm
9	30.8	25	16.3	12.5	7.9	19.25	5.8	4.1
15	39.2	33.3	24.6	12.5	7.9	27.7	5.8	4.1
25	53.05	47.05	38.4	12.5	7.9	41.2	5.8	4.1
37	69.4	63.5	54.8	12.5	7.9	57.5	5.8	4.1
50	67	61	52.2	15.3	10.9	55	6	4.1

Watertight Frame

STANDARD FRAME

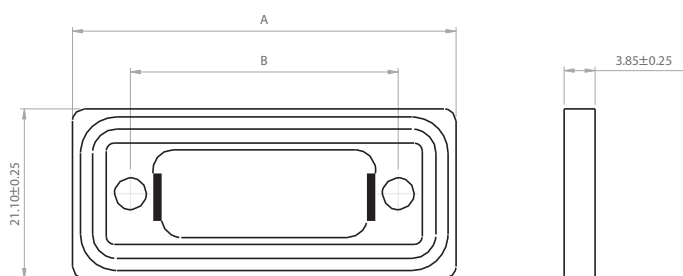

SHELL SIZE	A±0.25mm	B±0.25mm
9	39.2	24.8
15	47.7	33.3
25	61.2	46.8
37	77.5	63.1

Waterproof High Density

High Density 90° Connector

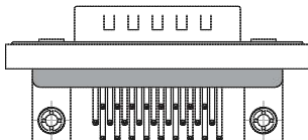
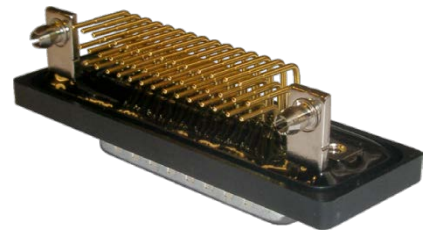
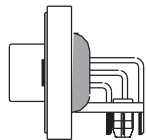
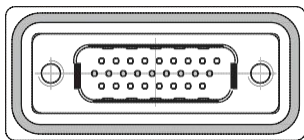

High Density 90° Connector PCB Layout

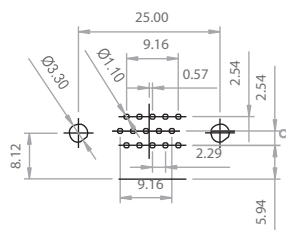

15 TYPE

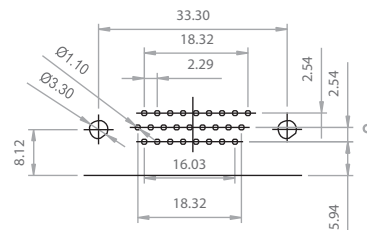

26 TYPE

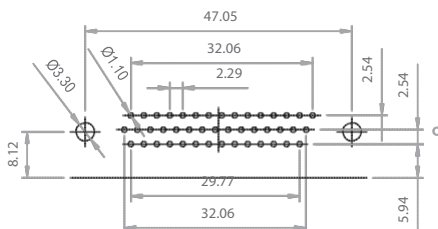

44 TYPE

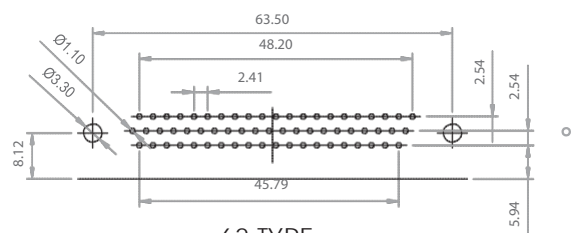

62 TYPE

Waterproof High Density

High Density Straight Connector

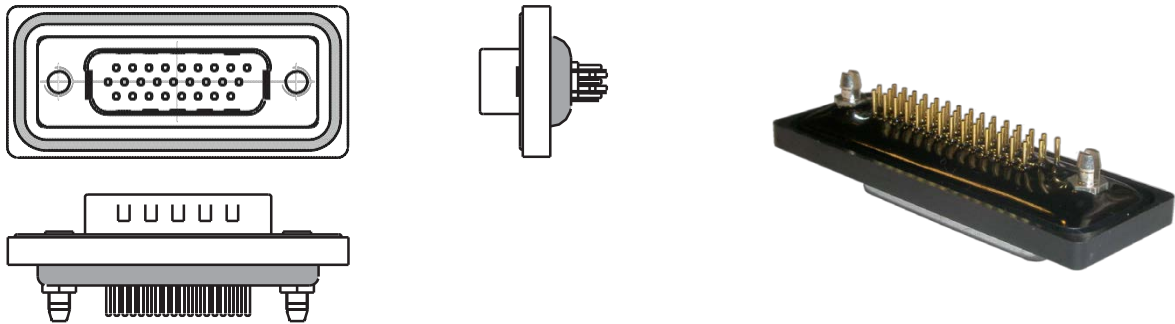

High Density Straight Connector PCB Layout

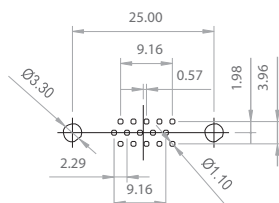

15 TYPE

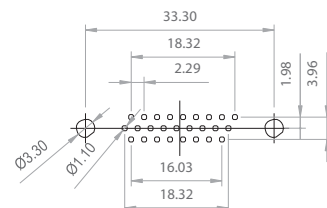

26 TYPE

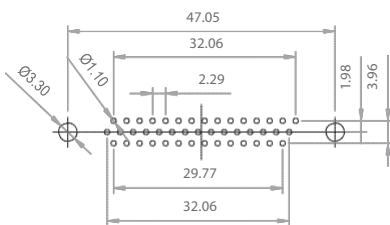

44 TYPE

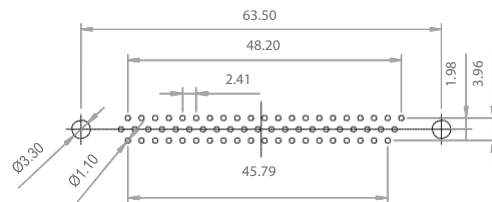

62 TYPE

Waterproof High Density

High Density Solder Connector

