

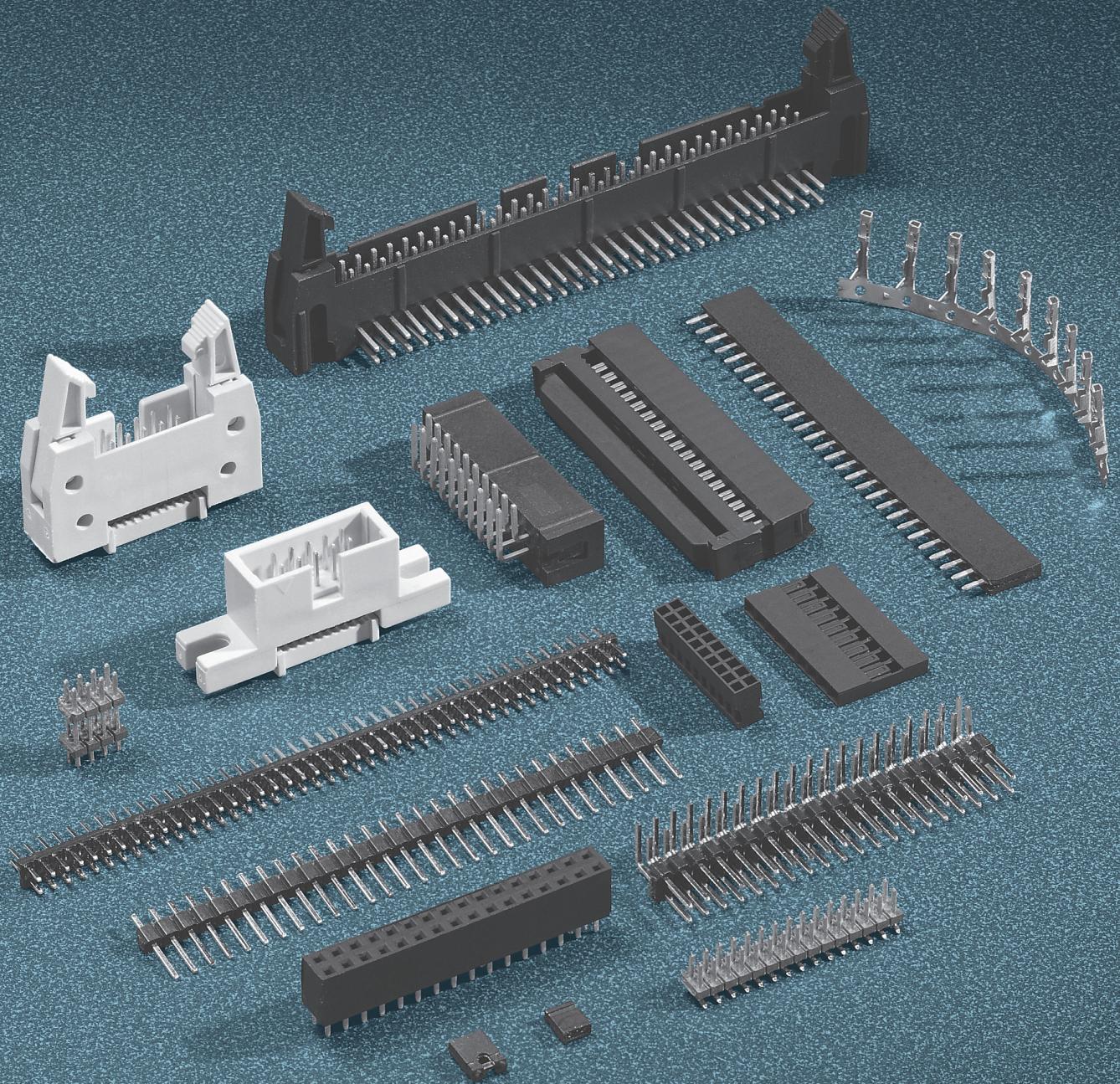

PIN HEADERS / RECEPTACLES



Power Dynamics Pin Headers and Receptacles are designed to meet today's needs for rugged and diverse interconnect products. They are available in 1.27mm, 2.0mm, and 2.54mm centers, and 1 through 80 contacts. Mounting options include P.C.B., I.D.C., crimp, and surface mount. Most Power Dynamics Pin Headers/Receptacles carry  safety approval.

PDI[®]
Power Dynamics, Inc.

EXAMPLE & ORDERING CODE

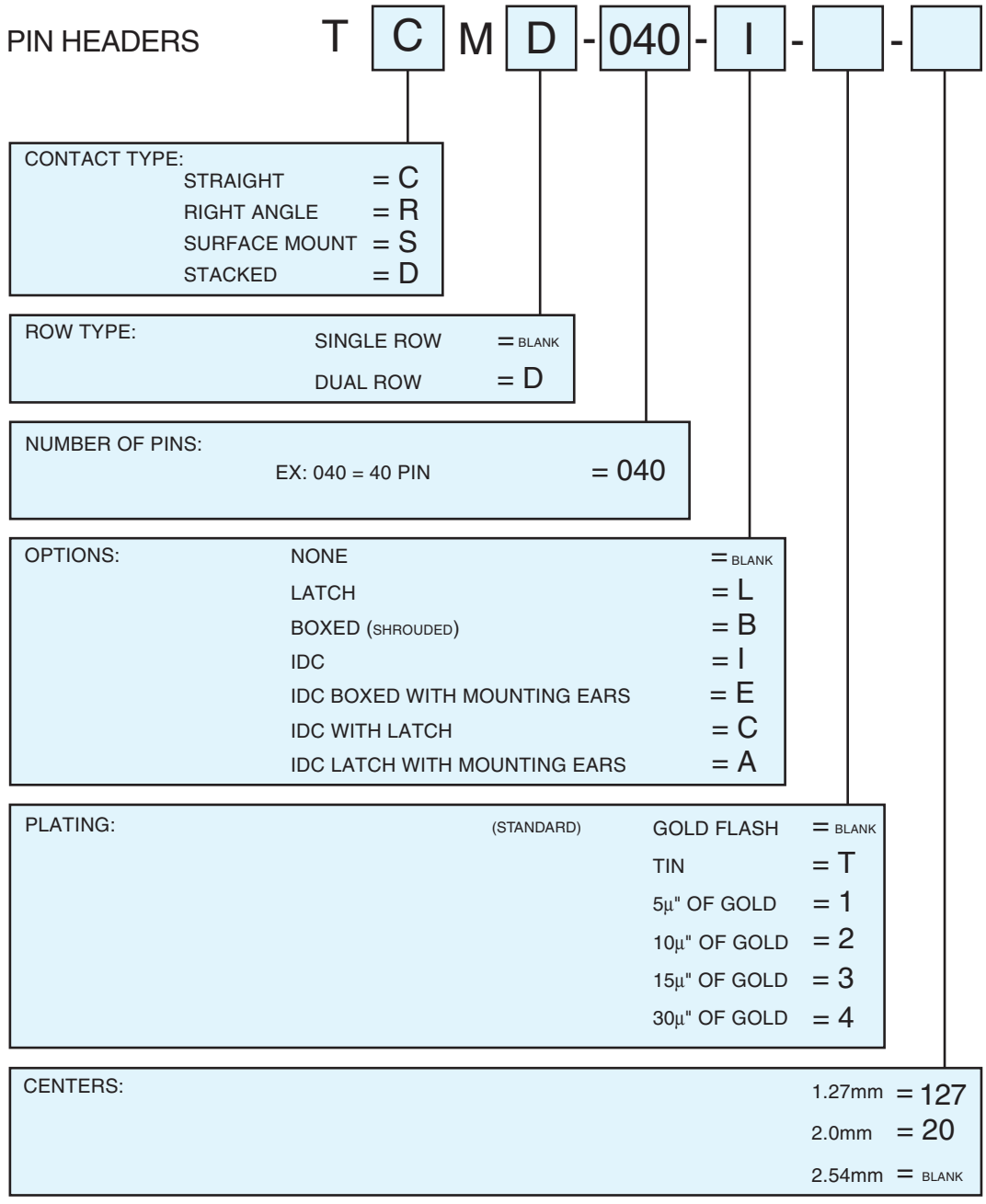

SPECIFICATIONS

MATERIAL AND FINISH:

Housing:
 Material: P.B.T.; Valox 420-SEO, Nylon 6T
 Rating: UL 94V-0

Contacts:
 Material: Brass
 Plating: Gold Flash

ELECTRICAL SPECIFICATIONS:

Current Rating: 3A

Insulator Resistance: 1000 Megaohm min.

Dielectric Withstanding Strength:
 1000 VAC rms for 1 minute

Temperature: -55°C to 105°C



145 Algonquin Parkway, Whippany, NJ 07981 • 973-560-0019 • FAX: 973-560-0076
 e-mail: sales@powerdynamics.com • www.powerdynamics.com

EXAMPLE & ORDERING CODE

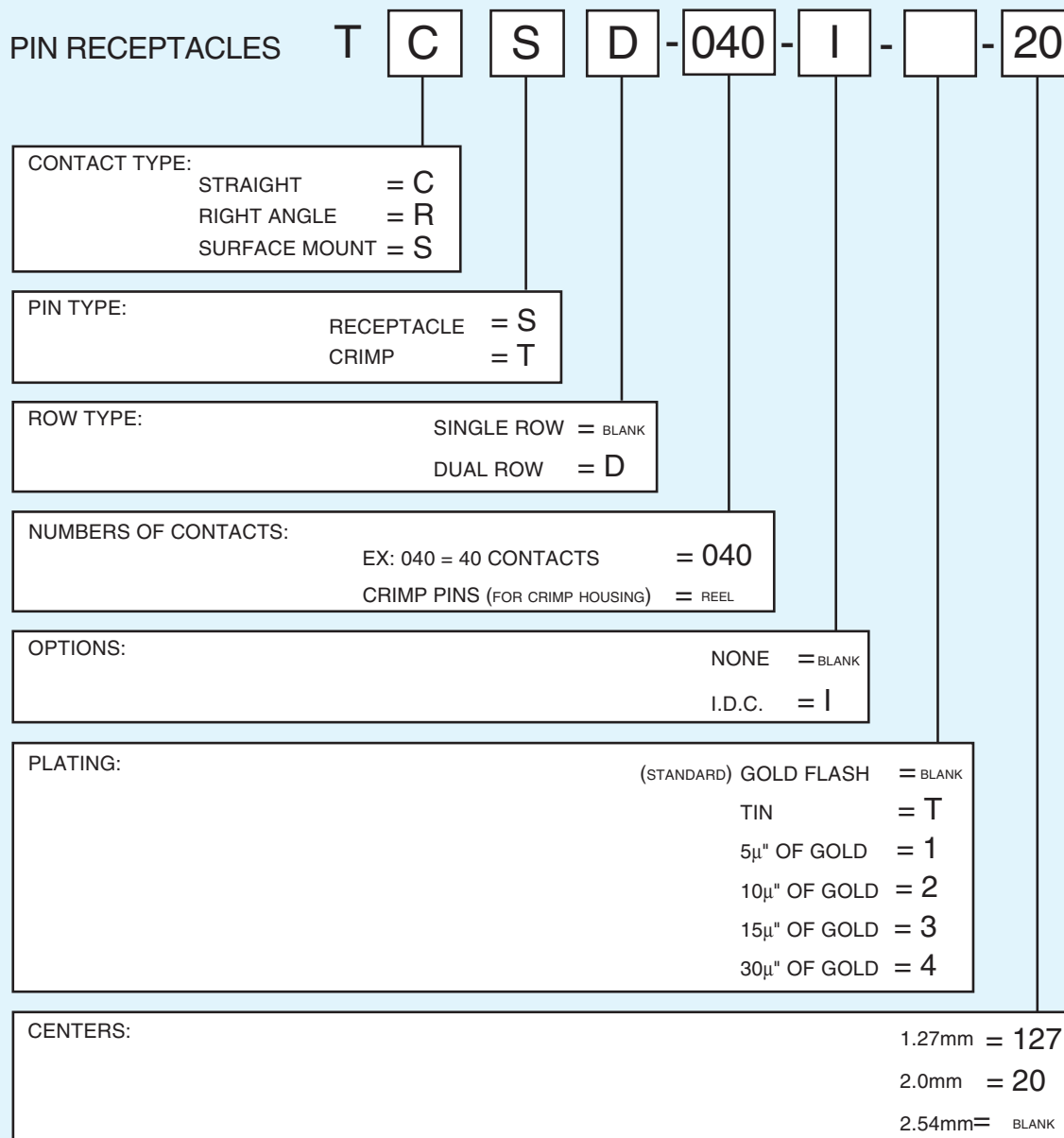

SPECIFICATIONS

MATERIAL AND FINISH:

Housing:

Material: P.B.T. glass filled, Nylon 6T
 Rating: UL 94V-0

Contacts:

Material: Phosphor Bronze
 Plating: Gold Flash

ELECTRICAL SPECIFICATIONS:

Current Rating: 1A

Insulator Resistance: 1000 Megaohm min. @ 500 VDC

Dielectric Withstanding Strength: 500 VDC for 1 min.

Contact Resistance: 30 milliohms max. @ 6 VDC at .3A

Temperature: -55°C to 105°C



Pin Header, 2.54mm, P.C.B.



TCM-018
(shown)

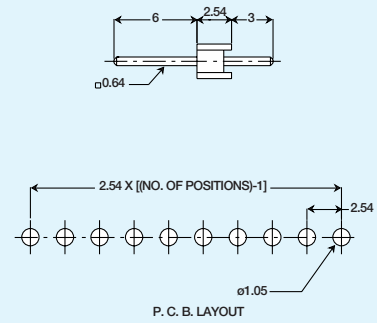
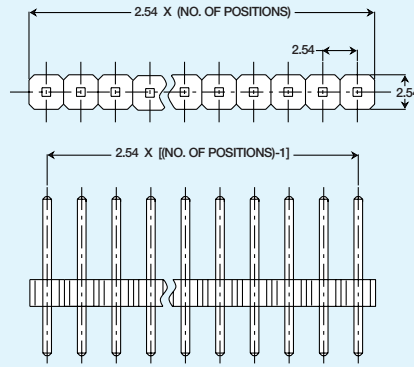

Available in 1-40 contacts.

TRM-020
(shown)

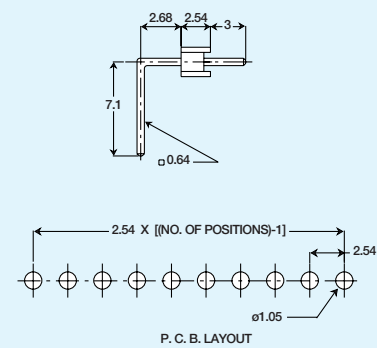
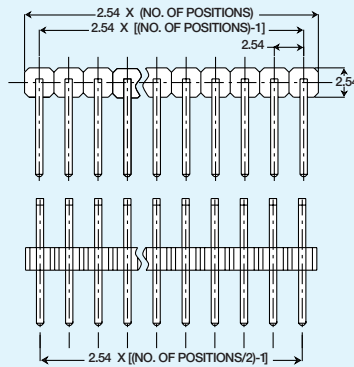
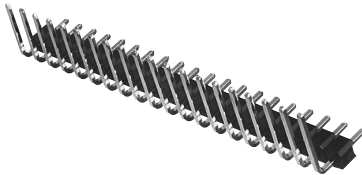

Available in 1-40 contacts.

TCMD-036
(shown)

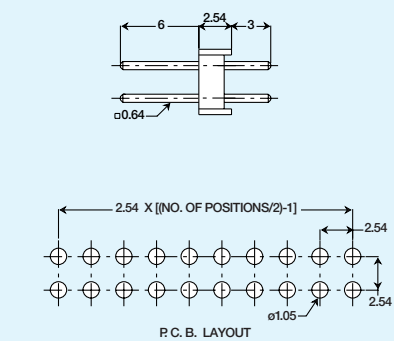
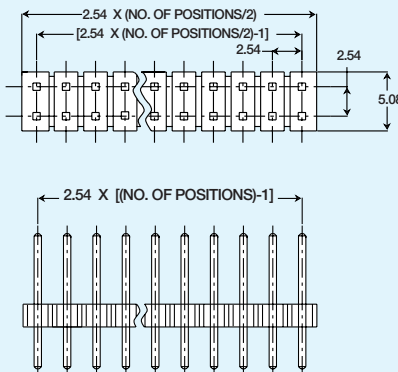
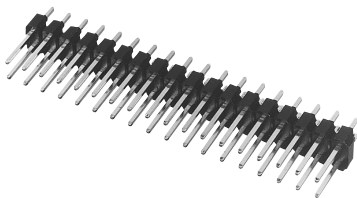

Available in 2-80 contacts.

TRMD-036
(shown)

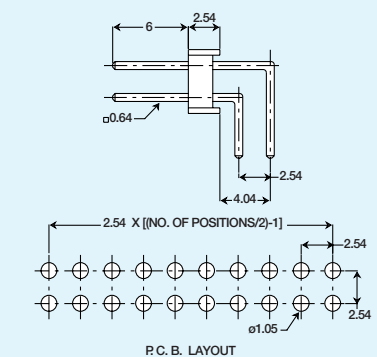
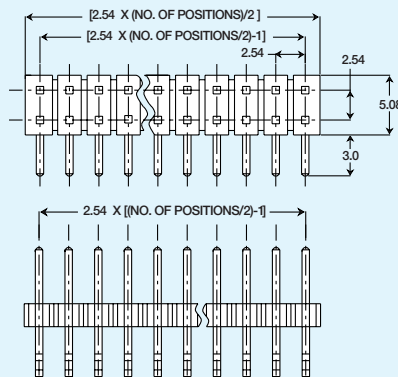

Available in 2-80 contacts.

Specifications subject to change without notice. Dimensions in mm.



145 Algonquin Parkway, Whippany, NJ 07981 • 973-560-0019 • FAX: 973-560-0076
e-mail: sales@powerdynamics.com • www.powerdynamics.com

Pin Receptacle, 2.54mm, P.C.B.



TCS-010
(shown)

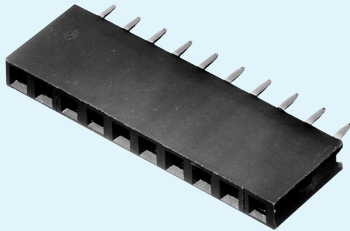

Available in 4-40 contacts.

TRS-010
(shown)

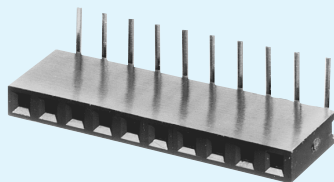

Available in 4-40 contacts.

TCSD-016
(shown)

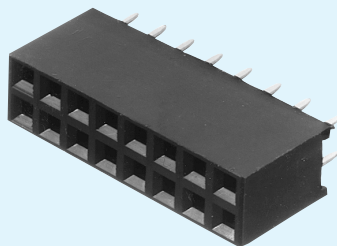

Available in 8-80 contacts.

TRSD-020
(shown)

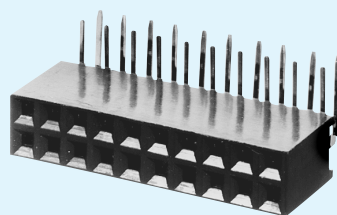

Available in 8-80 contacts.

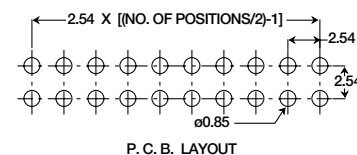
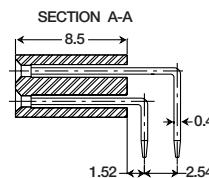
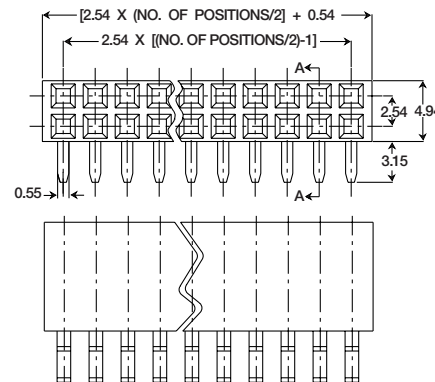
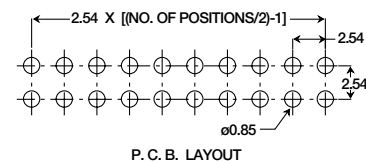
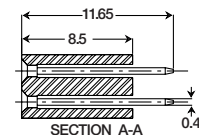
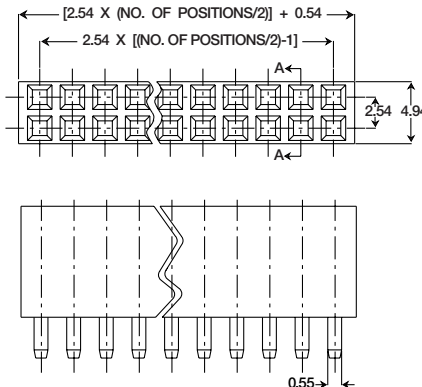
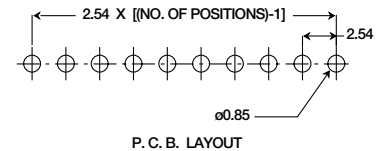
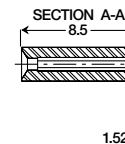
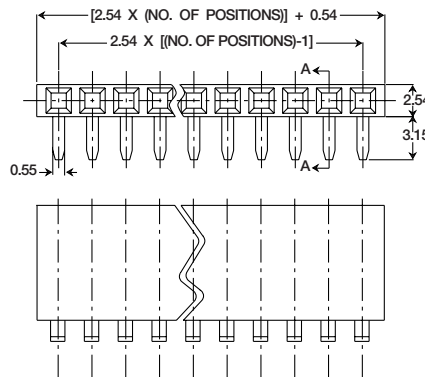
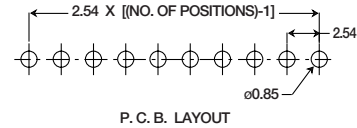
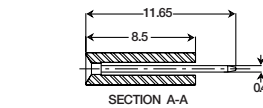
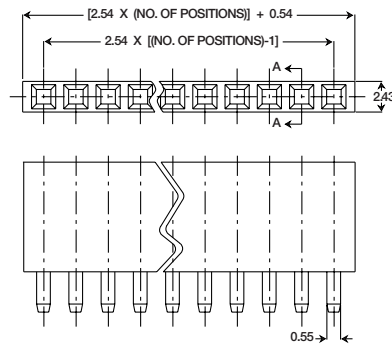

Specifications subject to change without notice. Dimensions in mm.

Pin Header, 2.54mm, P.C.B., Boxed



TCMD-034-B
(shown)

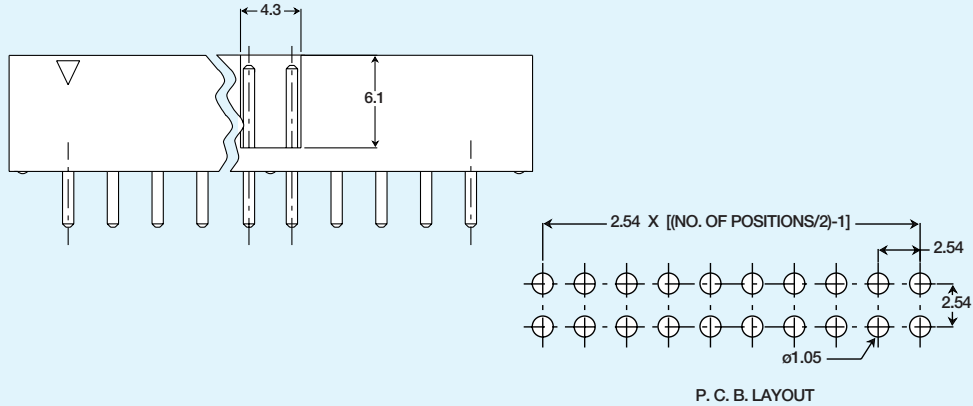
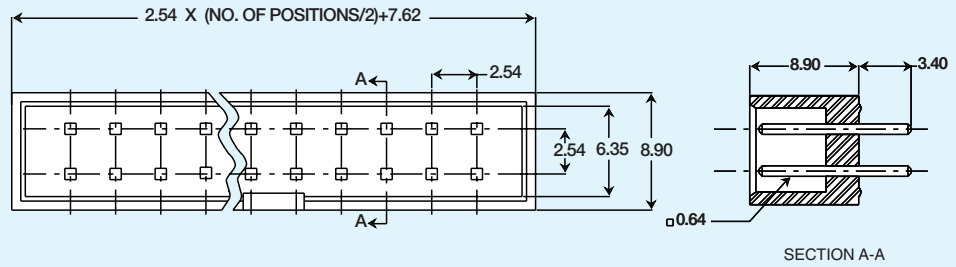
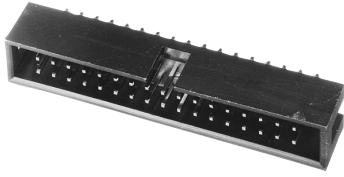

Available in 10, 14, 16, 20, 24, 26, 30, 34, 40, 50, 60, and 64 contacts.

TRMD-034-B
(shown)

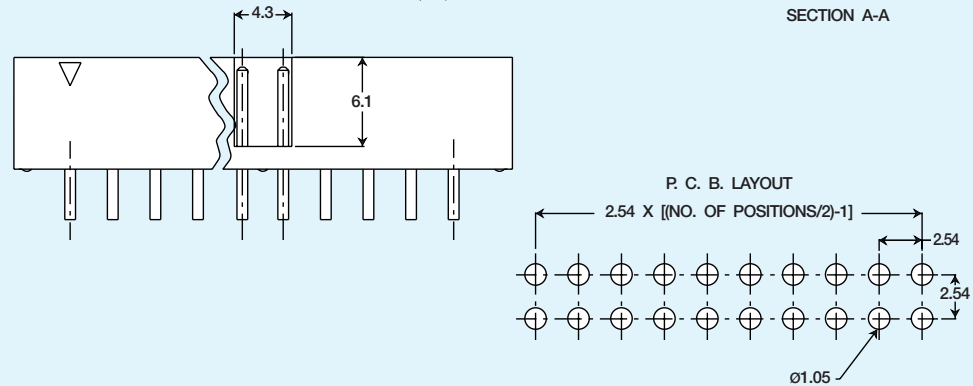
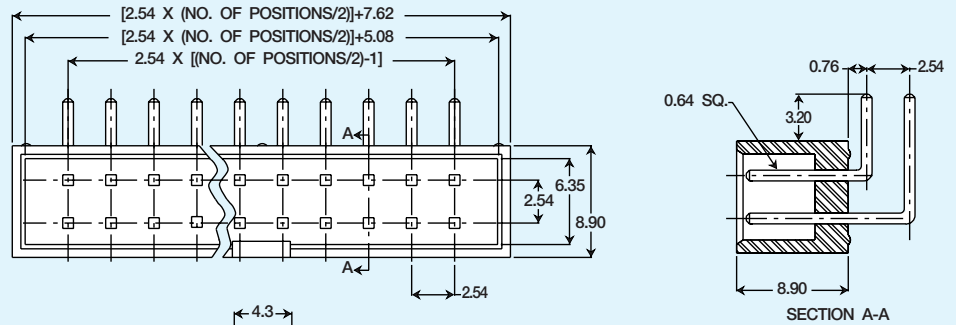
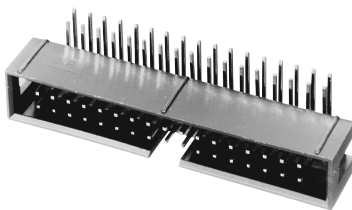

Available in 10, 14, 16, 20, 24, 26, 30, 34, 40, 50, 60, and 64 contacts.

Specifications subject to change without notice. Dimensions in mm.



145 Algonquin Parkway, Whippany, NJ 07981 • 973-560-0019 • FAX: 973-560-0076
e-mail: sales@powerdynamics.com • www.powerdynamics.com

Pin Header, 2.54mm, P.C.B., Latched



TCMD-020-L
(shown)

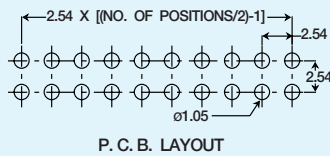
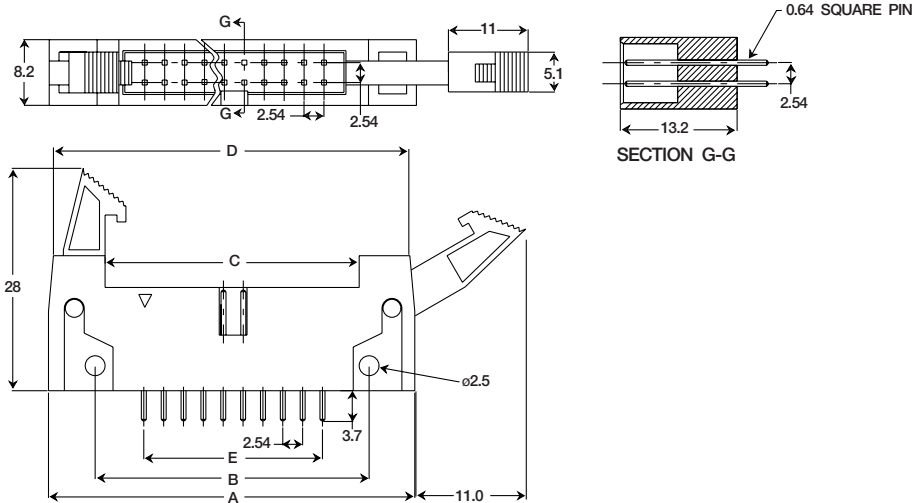
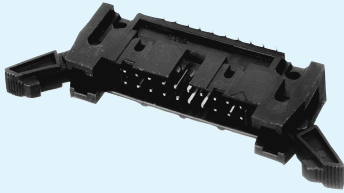

	NUMBER OF PINS											
	10	14	16	20	24	26	30	34	40	50	60	64
A	32.0	37.08	39.62	44.70	49.78	52.32	57.4	62.48	70.10	82.8	95.50	100.58
B	21.84	26.92	29.46	34.54	39.62	42.16	47.28	52.32	59.94	72.64	85.34	90.42
C	17.91	22.99	25.53	30.61	35.69	38.23	43.31	48.39	56.01	68.71	81.41	86.49
D	29.9	34.98	37.52	42.60	47.68	50.22	55.3	60.38	68.00	80.70	93.40	98.49
E	10.16	15.24	17.78	22.86	27.94	30.48	35.56	40.64	48.26	60.96	73.66	78.74

TRMD-020-L
(shown)

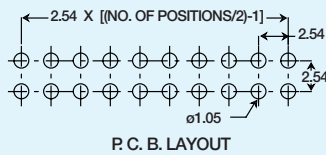
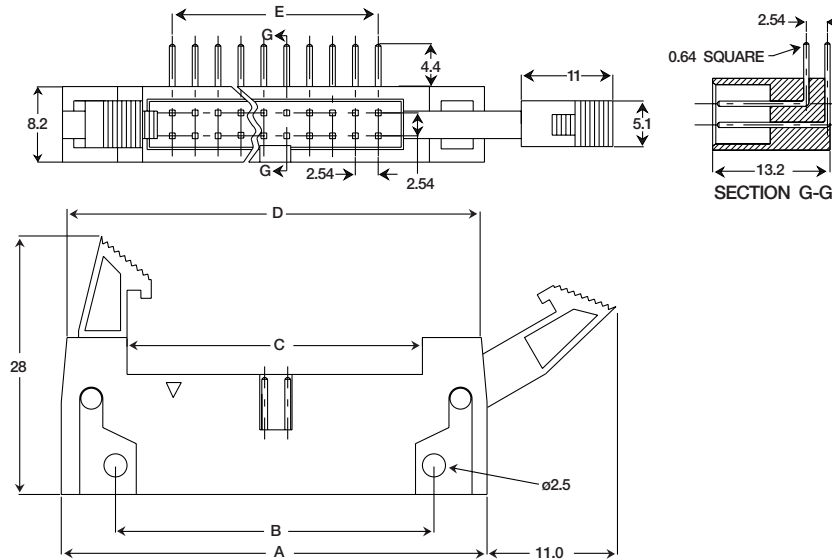
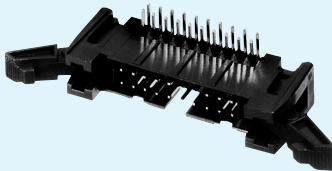

	NUMBER OF PINS											
	10	14	16	20	24	26	30	34	40	50	60	64
A	32.0	37.08	39.62	44.70	49.78	52.32	57.4	62.48	70.10	82.8	95.50	100.58
B	21.84	26.92	29.46	34.54	39.62	42.16	47.28	52.32	59.94	72.64	85.34	90.42
C	17.91	22.99	25.53	30.61	35.69	38.23	43.31	48.39	56.01	68.71	81.41	86.49
D	29.9	34.98	37.52	42.60	47.68	50.22	55.3	60.38	68.00	80.70	93.40	98.49
E	10.16	15.24	17.78	22.86	27.94	30.48	35.56	40.64	48.26	60.96	73.66	78.74

Specifications subject to change without notice. Dimensions in mm.

Pin Header, 2.54mm, I.D.C.



TCMD-026-I
(shown)

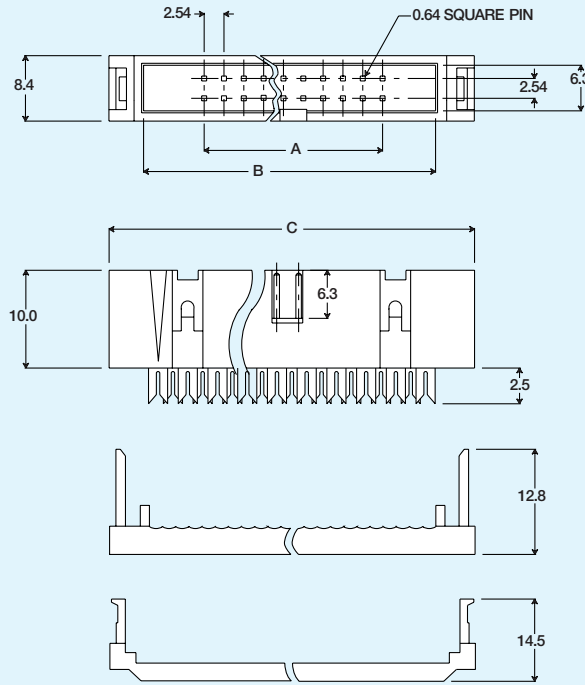
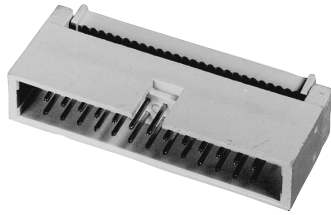

	A	B	C
10	10.16	18.00	23.00
14	15.24	23.08	28.08
16	17.78	25.62	30.62
20	22.96	30.70	35.70
24	27.94	35.78	40.78
26	30.48	38.32	43.32
30	35.56	43.40	48.40
34	40.64	48.48	53.48
40	48.26	56.10	61.10
50	60.96	68.90	73.90
60	73.66	81.60	86.60
64	78.74	86.68	91.68

8

PIN HEADERS / RECEPTACLES

TCMD-020-E
(shown)

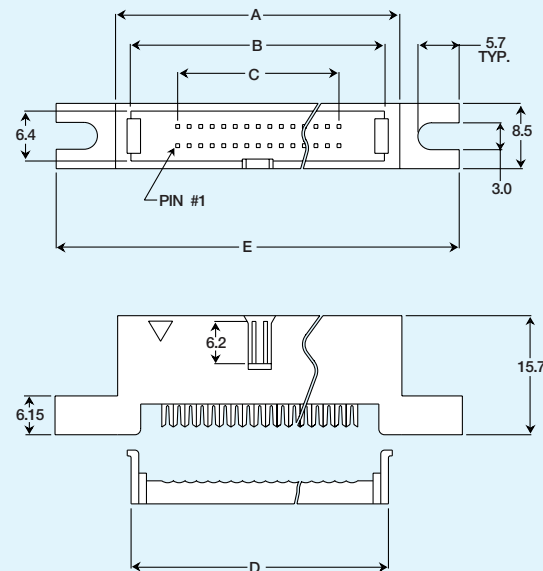
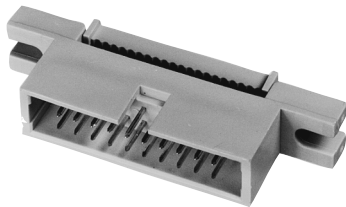

	A	B	C	D	E
10	21.40	18.30	10.16	17.34	36.80
14	26.48	23.38	15.24	22.42	41.88
16	29.02	25.92	17.78	24.96	44.42
20	34.10	31.00	22.86	30.04	49.50
24	39.18	36.08	27.94	35.12	54.58
26	41.72	38.62	30.48	37.66	57.12
30	46.80	43.70	35.56	42.74	62.20
34	51.88	48.78	40.64	47.82	67.28
40	59.50	56.40	48.26	55.44	74.99
50	72.20	69.10	60.96	68.14	87.60
60	84.90	81.80	73.66	80.84	100.30
64	89.98	86.88	78.74	85.92	105.38

Specifications subject to change without notice. Dimensions in mm.
Custom cable assemblies also available. See page 254.



145 Algonquin Parkway, Whippany, NJ 07981 • 973-560-0019 • FAX: 973-560-0076
e-mail: sales@powerdynamics.com • www.powerdynamics.com

Pin Header, 2.54mm, I.D.C.



TCMD-020-C
(shown)

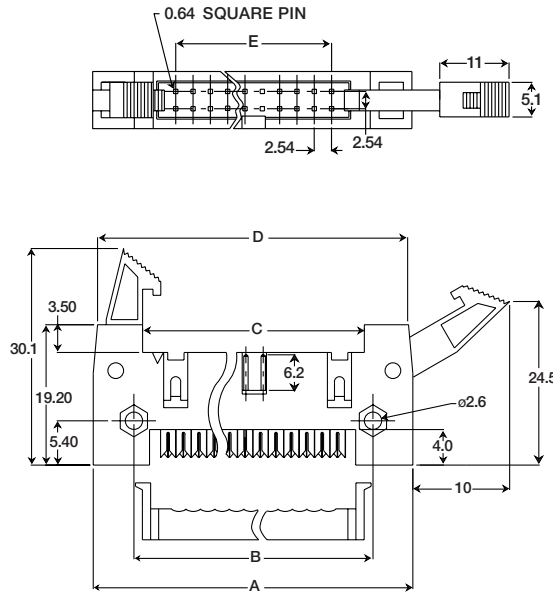
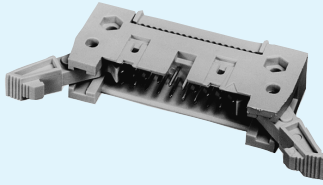

	A	B	C	D	E
10	32.0	21.84	18.10	29.9	10.16
14	37.08	26.92	23.18	34.98	15.24
16	39.62	29.46	25.72	37.52	17.78
20	44.70	34.54	30.80	42.60	22.86
24	49.78	39.62	35.88	47.68	27.94
26	52.32	42.16	38.42	50.22	30.48
30	57.4	47.24	43.50	55.3	35.56
34	62.48	52.32	48.58	60.38	40.64
40	70.10	59.94	56.20	68.00	48.26
50	82.8	72.64	68.90	80.70	60.96
60	95.50	85.34	81.60	93.40	73.66
64	100.58	90.42	86.68	98.48	78.74

TCMD-026-A
(shown)

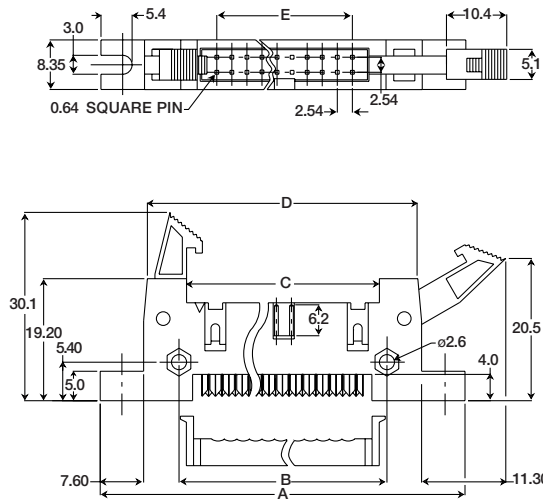
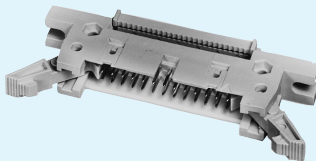

	A	B	C	D	E
10	47.20	21.84	18.10	29.9	10.16
14	52.28	26.92	23.18	34.98	15.24
16	54.82	29.46	25.72	37.52	17.78
20	59.90	34.54	30.80	42.60	22.86
24	64.98	39.62	35.88	47.68	27.94
26	67.52	42.16	38.42	50.22	30.48
30	72.60	47.24	43.50	55.3	35.56
34	77.68	52.32	48.58	60.38	40.64
40	85.30	59.94	56.20	68.00	48.26
50	98.00	72.64	68.90	80.70	60.96
60	110.70	85.34	81.60	93.40	73.66
64	115.78	90.42	86.68	98.48	78.74

Specifications subject to change without notice. Dimensions in mm.
Custom cable assemblies also available. See page 254.

Pin Header, 2.0mm, P.C.B.



TCM-019-20
(shown)

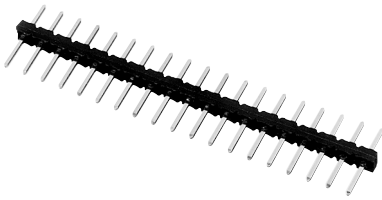

Available in 1-40 contacts.

TRM-019-20
(shown)



Available in 1-40 contacts.

TCMD-038-20
(shown)

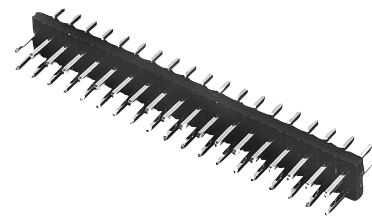

Available in 2-80 contacts.

TRMD-038-20
(shown)

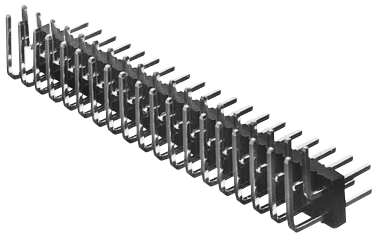

Available in 2-80 contacts.

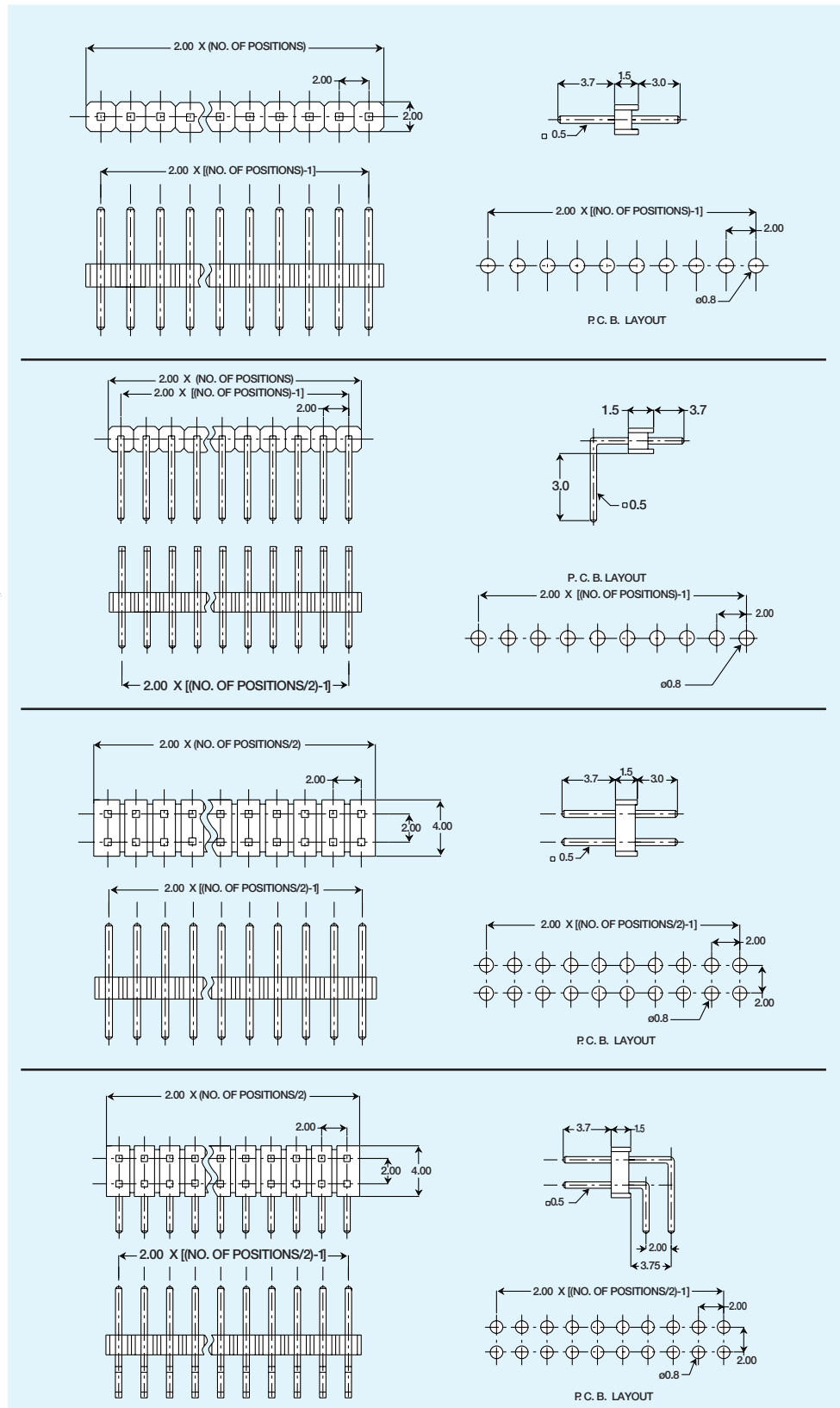

Specifications subject to change without notice. Dimensions in mm.



145 Algonquin Parkway, Whippany, NJ 07981 • 973-560-0019 • FAX: 973-560-0076
e-mail: sales@powerdynamics.com • www.powerdynamics.com

Pin Receptacle, 2.0mm, P.C.B.



TCS-009-20
(shown)

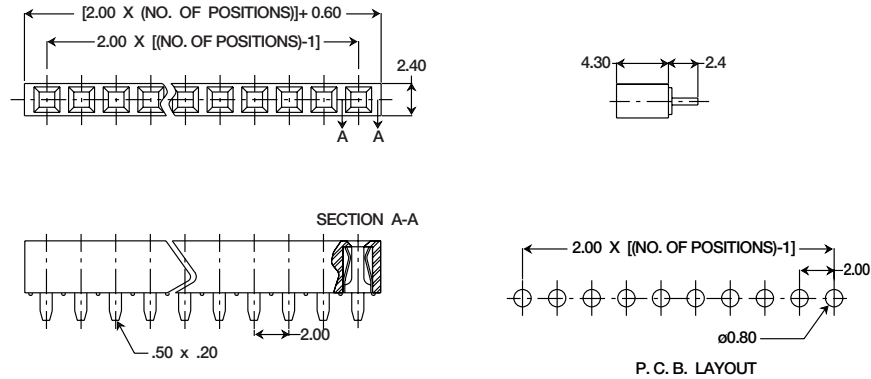
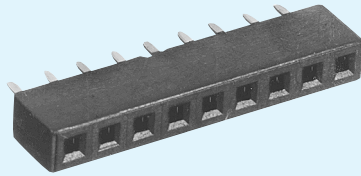

Available in 4-40 contacts.

TCSD-020-20
(shown)

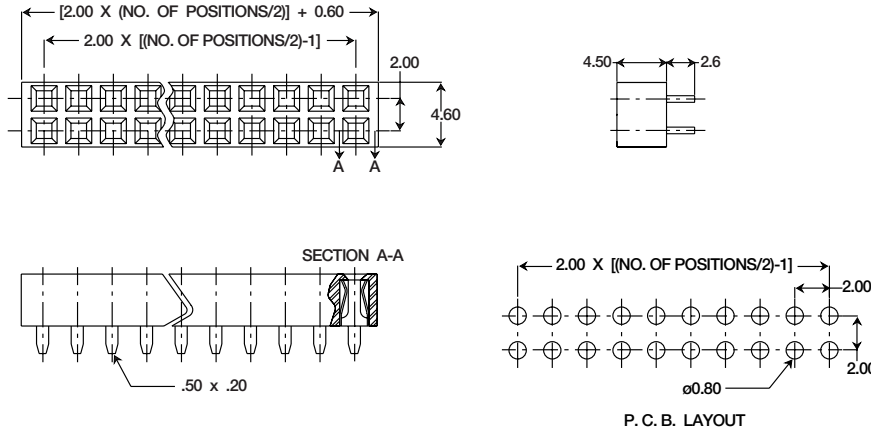
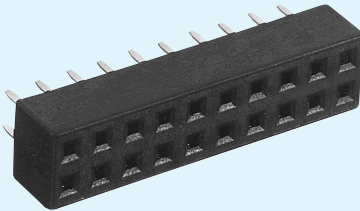

Available in 8-80 contacts.

TRSD-020-20
(shown)

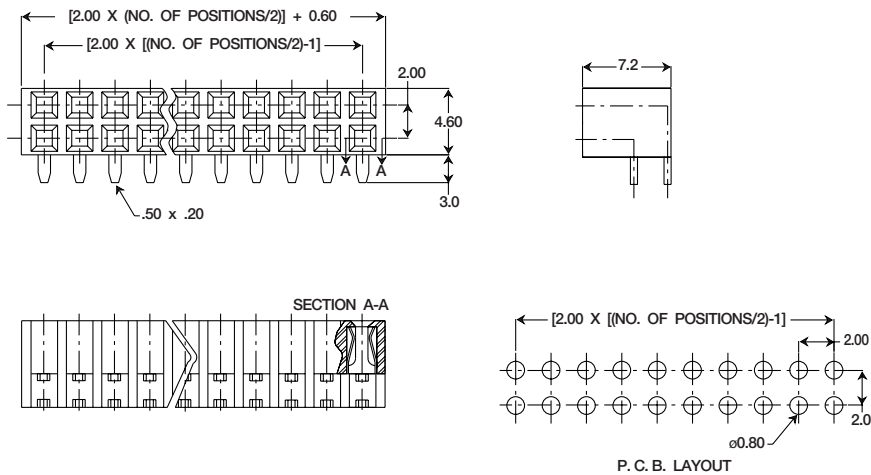
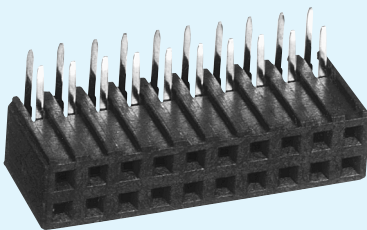

Available in 8-80 contacts.

Specifications subject to change without notice. Dimensions in mm.

Pin Headers and Receptacle, 1.27mm, P.C.B.

TCM-032-127
(shown)

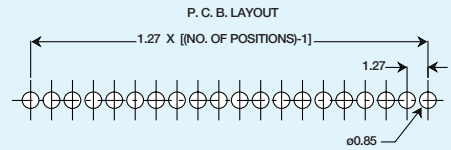
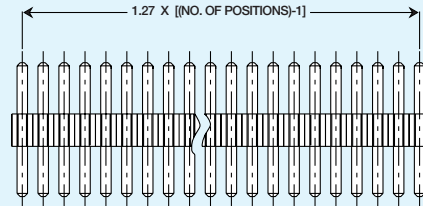
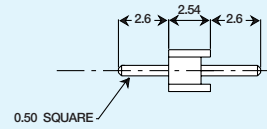
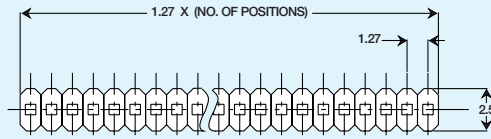

Available in 1-32 contacts.

TCMD-100-127
(shown)

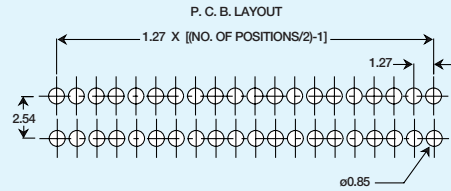
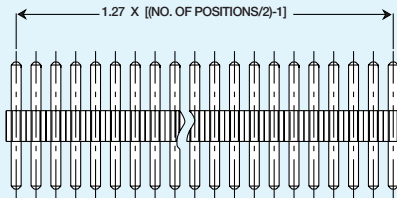
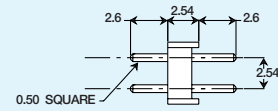
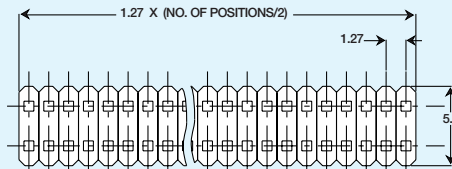
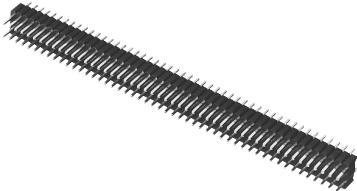

Available in 2-100 contacts.

TCS-040-127
(shown)

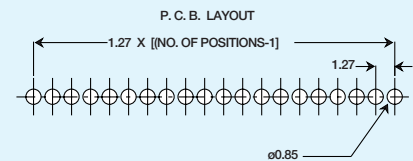
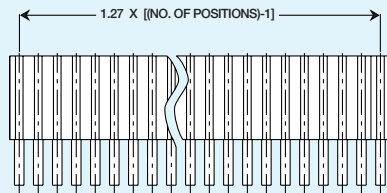
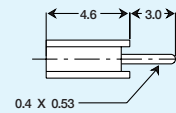
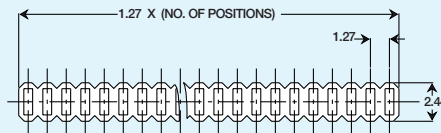
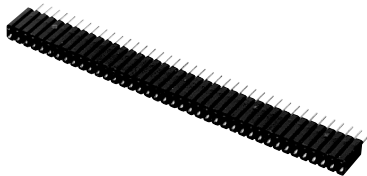

Available in 4-50 contacts.

Specifications subject to change without notice. Dimensions in mm.



145 Algonquin Parkway, Whippany, NJ 07981 • 973-560-0019 • FAX: 973-560-0076
e-mail: sales@powerdynamics.com • www.powerdynamics.com

Pin Header, 1.27mm, P.C.B., Boxed and Latched

TCMD-034-B-127

(shown)

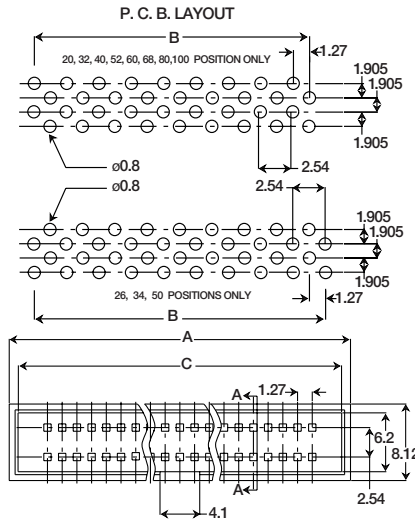
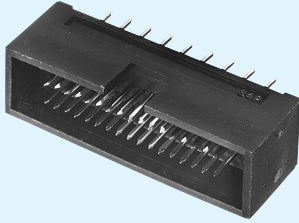

POSITION	DIMENSION		
	A	B	C
20	20.95	11.43	18.75
26	24.76	15.24	22.56
32	28.57	19.05	26.37
34	29.84	20.32	27.64
40	33.65	24.13	31.45
50	40.00	30.48	37.80
52	41.27	31.75	39.07
60	46.35	36.83	44.15
68	51.43	41.91	49.23
80	59.05	49.53	56.85
100	71.75	62.23	69.55

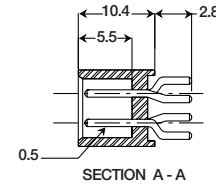

TRMD-080-B-127

(shown)

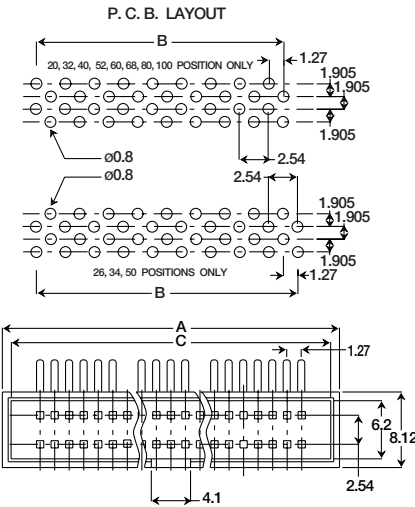
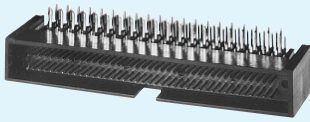

POSITION	DIMENSION		
	A	B	C
20	20.95	11.43	18.75
26	24.76	15.24	22.56
32	28.57	19.05	26.37
34	29.84	20.32	27.64
40	33.65	24.13	31.45
50	40.00	30.48	37.80
52	41.27	31.75	39.07
60	46.35	36.83	44.15
68	51.43	41.91	49.23
80	59.08	49.53	56.85
100	71.75	62.23	69.55

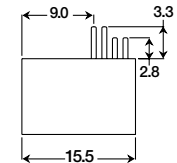

TCMD-034-L-127

(shown)

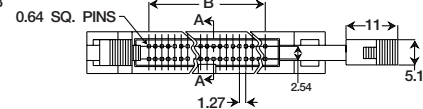
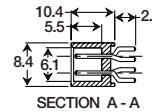
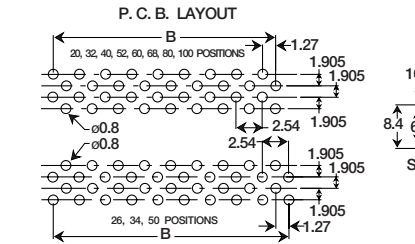
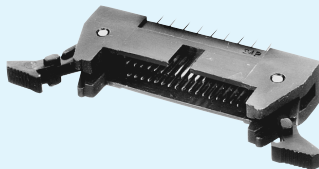

POSITION	DIMENSION		
	A	B	C
20	30.95	11.43	18.75
26	34.76	15.24	22.56
32	38.57	19.05	26.37
34	39.84	20.32	27.64
40	43.65	24.13	31.45
50	50.00	30.48	37.80
52	51.27	31.75	39.07
60	56.35	36.83	44.15
68	61.43	41.91	49.23
80	69.05	49.53	56.85
100	81.75	62.23	69.55

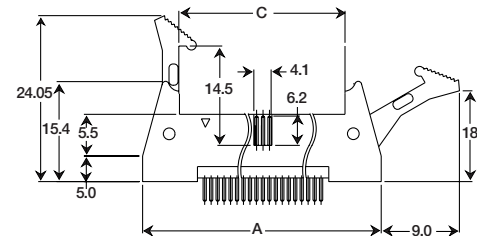

Specifications subject to change without notice. Dimensions in mm.

145 Algonquin Parkway, Whippany, NJ 07981 • 973-560-0019 • FAX: 973-560-0076
e-mail: sales@powerdynamics.com • www.powerdynamics.com

PDI[®]
Power Dynamics, Inc.

8

PIN HEADERS / RECEPTACLES

Pin Receptacle, I.D.C.



TCSD-034-I
(shown)

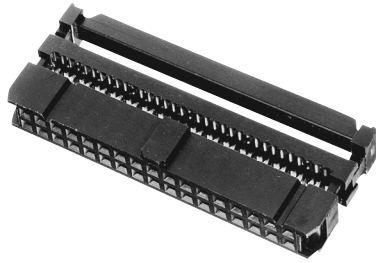

Available in 10, 14, 16, 20, 24, 26, 30, 34, 40, 50, 60, 64 contacts.

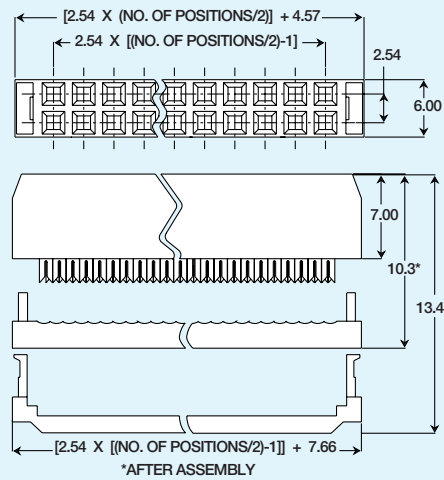

TCSD-040-I-20
(shown)

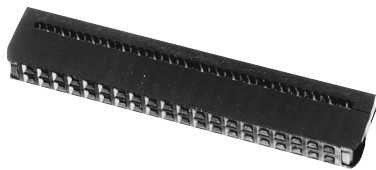

Available in 20, 22, 24, 26, 34, 40, 44, 50, 60, 68 contacts.

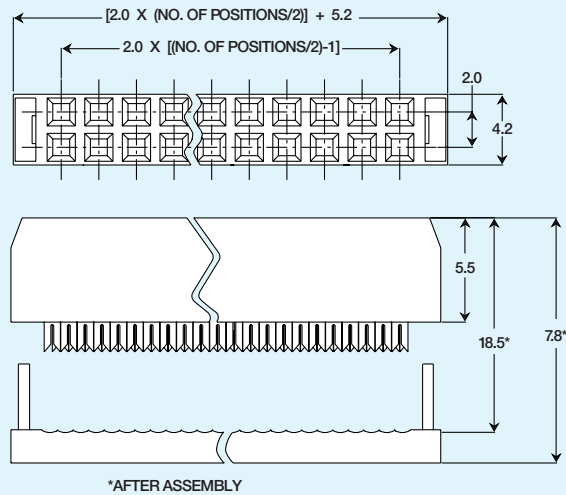

TCSD-034-I-127
(shown)

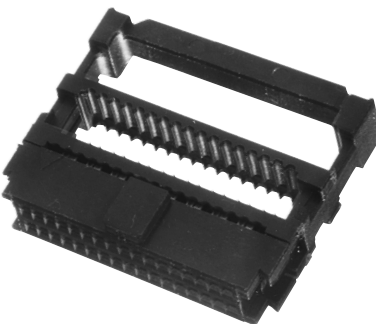

POSITION	DIMENSION			
	A	B	C	D
20	18.55	11.43	13.95	16.35
26	22.36	15.24	17.76	20.16
32	26.17	19.05	21.57	23.97
34	27.44	20.32	22.84	25.24
40	31.25	24.13	26.65	29.05
50	37.50	30.48	33.00	35.40
52	38.87	31.75	34.27	36.67
60	43.95	36.83	39.35	41.75
68	49.03	41.91	44.43	46.83
80	56.65	49.53	52.05	54.45
100	69.35	62.23	64.75	67.15

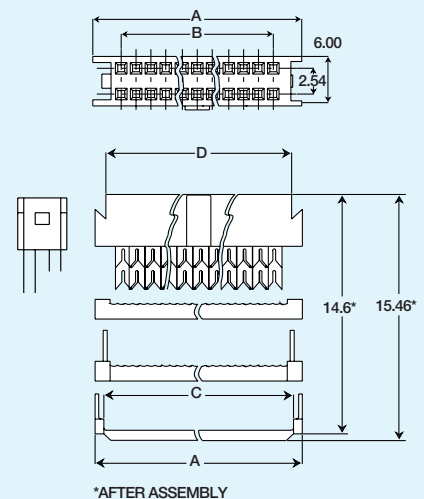

Specifications subject to change without notice. Dimensions in mm.
 Custom cable assemblies also available. See page 254.



145 Algonquin Parkway, Whippany, NJ 07981 • 973-560-0019 • FAX: 973-560-0076
 e-mail: sales@powerdynamics.com • www.powerdynamics.com

Pin Headers, 2.0mm, Surface Mount

TSM-016-20
(shown)

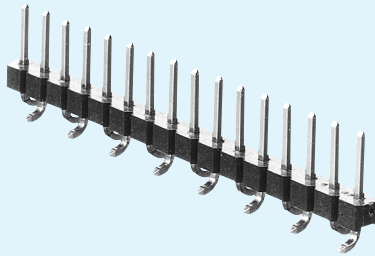

Available in 2-32 contacts.
Tape and reel packaging available.
Please contact PDI for ordering instructions.

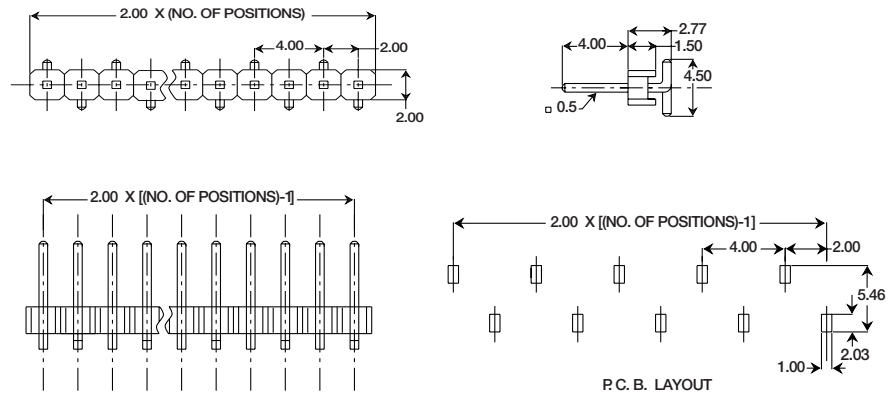

TSMD-040-20
(shown)

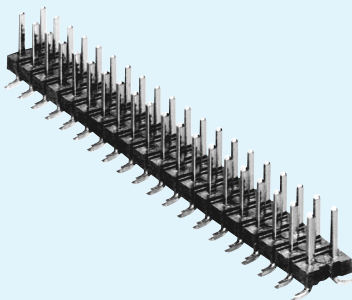

Available in 4-64 contacts.
Tape and reel packaging available.
Please contact PDI for ordering instructions.

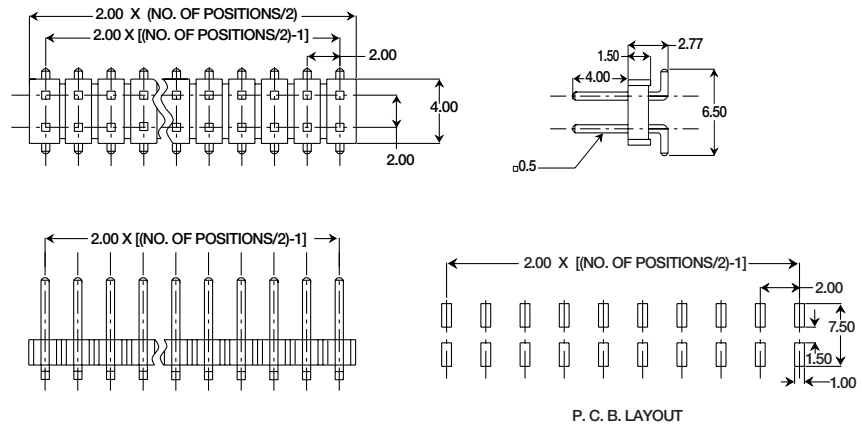

TSSD-016-20
(shown)

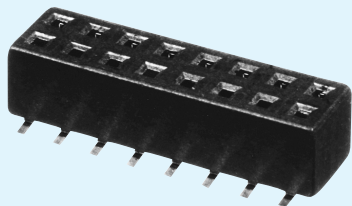

Available in 8-60 contacts.
Tape and reel packaging available.
Please contact PDI for ordering instructions.

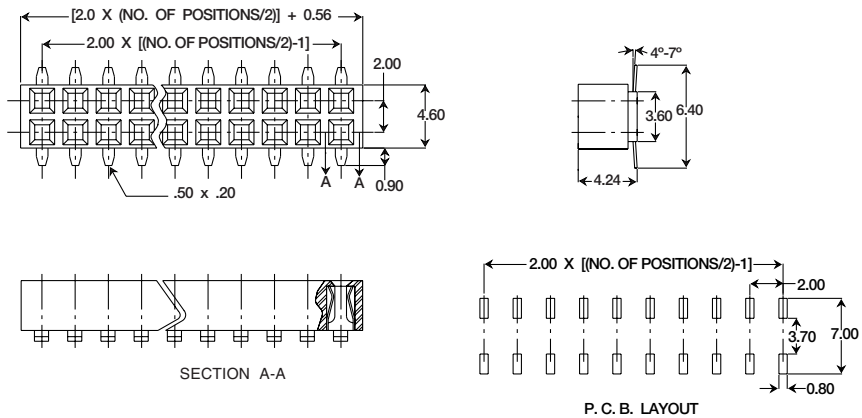

Specifications subject to change without notice. Dimensions in mm.

Pin Headers, Stacked, P.C.B.

TDMD-008
(shown)

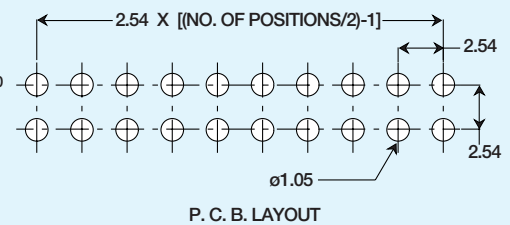
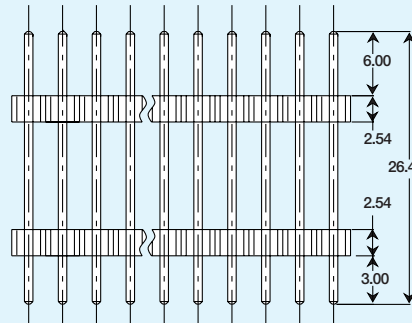
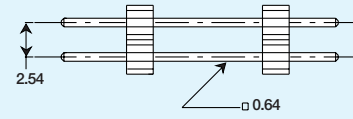
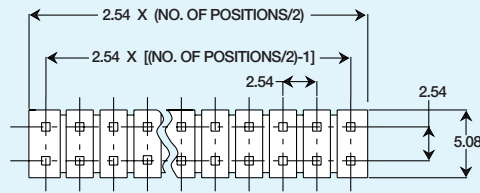
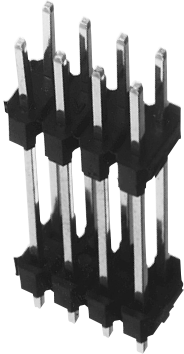

Available in 4-80 contacts.

TDMD-032-20
(shown)

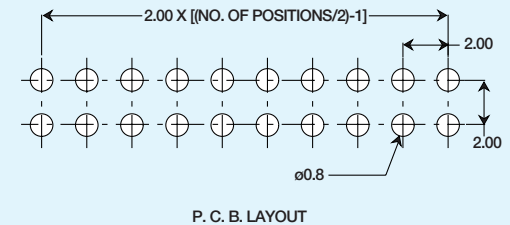
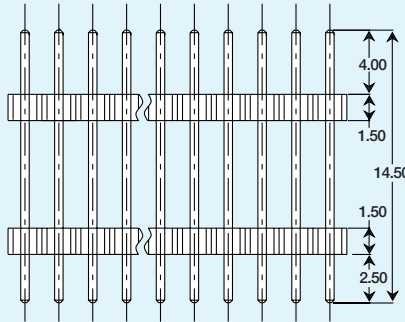
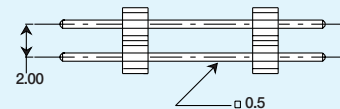
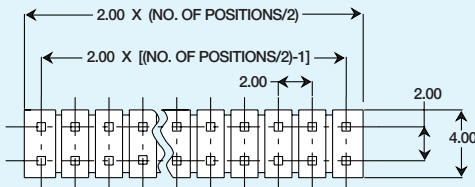
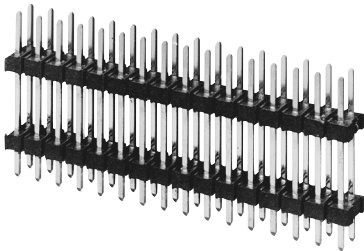

Available in 4-64 contacts.

Specifications subject to change without notice. Dimensions in mm.



145 Algonquin Parkway, Whippany, NJ 07981 • 973-560-0019 • FAX: 973-560-0076
e-mail: sales@powerdynamics.com • www.powerdynamics.com

Pin Receptacle, Crimp, 2.54mm and 2.0mm

TCT-004
(shown)

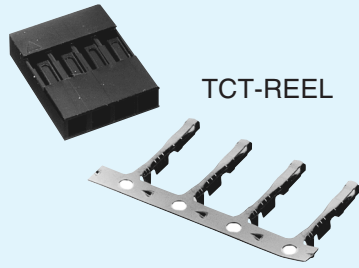

TCT-REEL

Available in 2-60 contacts.

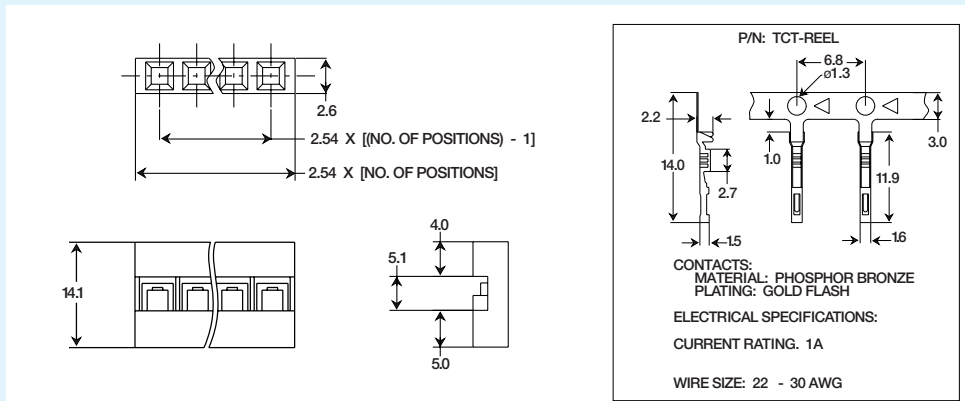

TCTD-020
(shown)

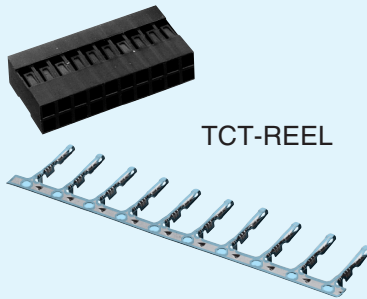

TCT-REEL

Available in 4-120 contacts.

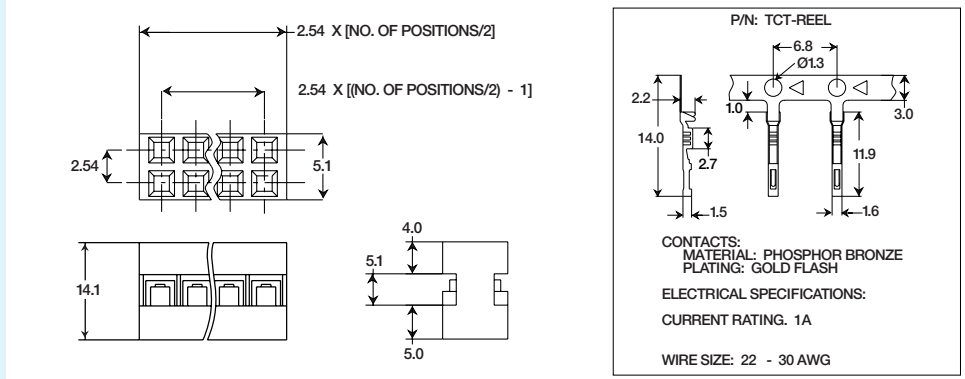

TCT-004-20
(shown)

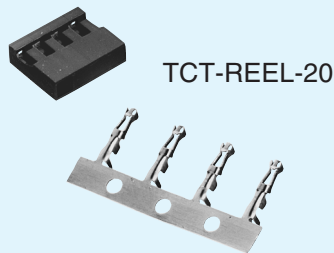

TCT-REEL-20

Available in 2-40 contacts.

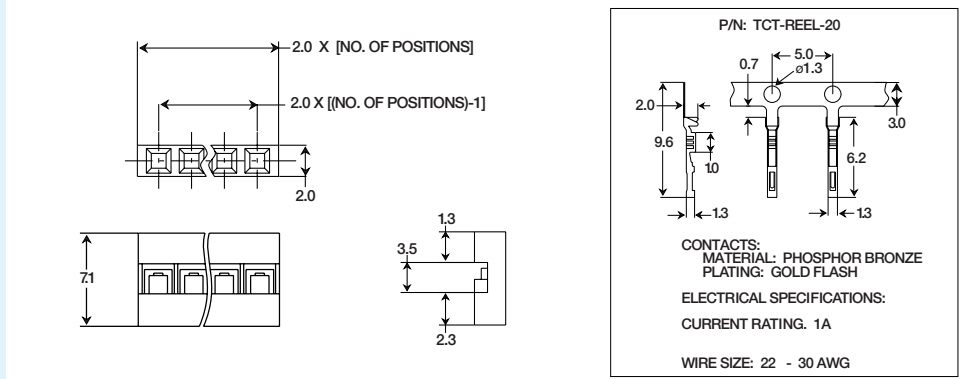

TCTD-020-20
(shown)

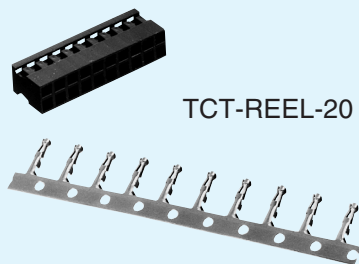

TCT-REEL-20

Available in 4-80 contacts.

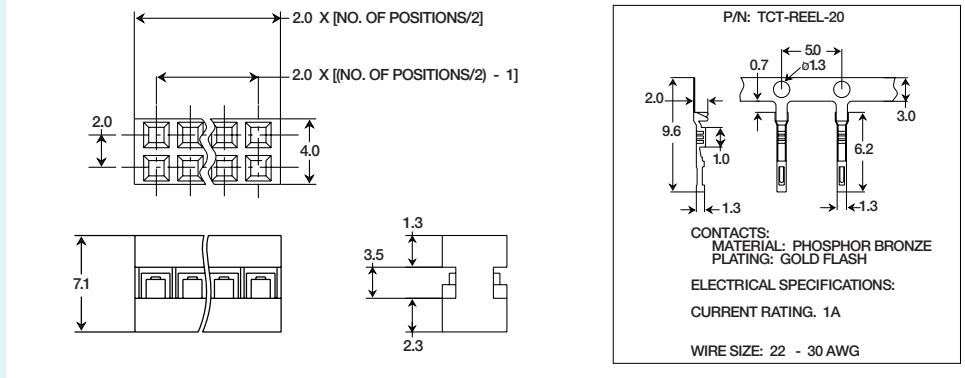

Specifications subject to change without notice. Dimensions in mm.
Custom cable assemblies also available. See page 290.

Shunt, 2.54mm and 2.0mm



PD-JPS-1-O
(shown)

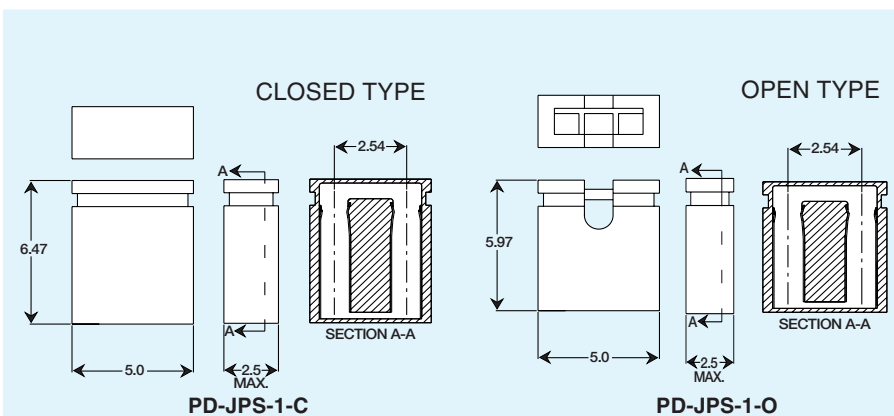
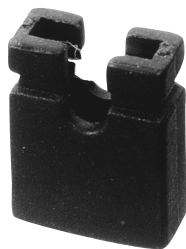

PD-JPS-1-CH
(shown)

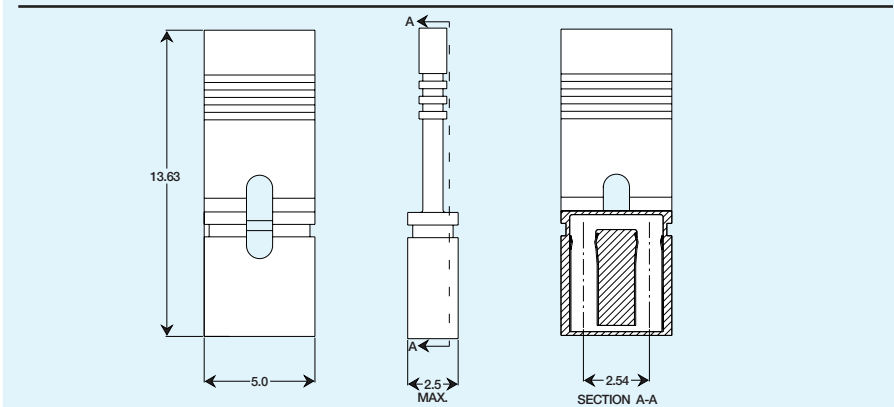

PD-JPS-08-O
(shown)

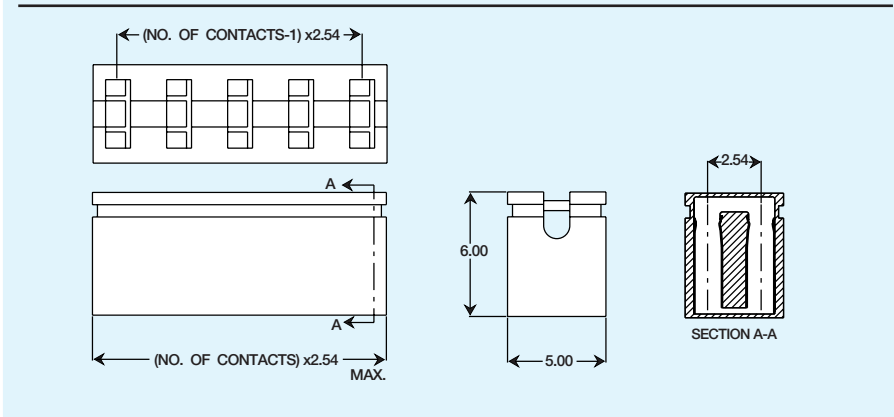

PD-JPS-1-C-20
(shown)

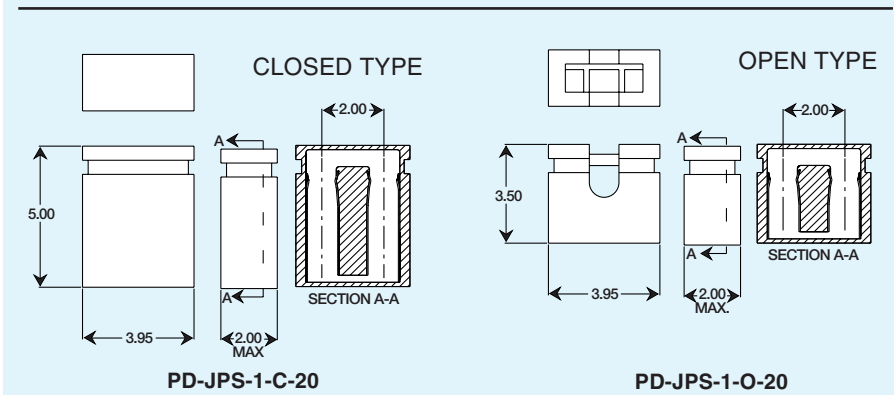
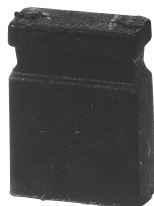

Specifications subject to change without notice. Dimensions in mm.